

Compact Explosionproof Solenoids

Ex ia – Ex d – Ex e mb – Ex m
For 551-553 Series Solenoid Valves



ASCO™

EMERSON™

Introduction

ASCO is the first to introduce a compact, low power flameproof solenoid operator with a mere 0.5W power consumption. Certified according to ATEX, IECEx, it is especially suited for applications in the process industry market where high levels of safety and superior resistance to corrosion are required.

The low wattage coil provides reduced battery drain and heat rise, reduced wiring cost and energy savings. The savings in power usage over the installed life of the solenoid valve will lower the total cost of ownership.

Application

The solenoid valves are mainly used to control single acting, spring return actuators driving all kinds of process and shutdown valves such as butterfly and ball valves. Flameproof operators are particularly well adapted in chemical, petrochemical and pharmaceutical industries.

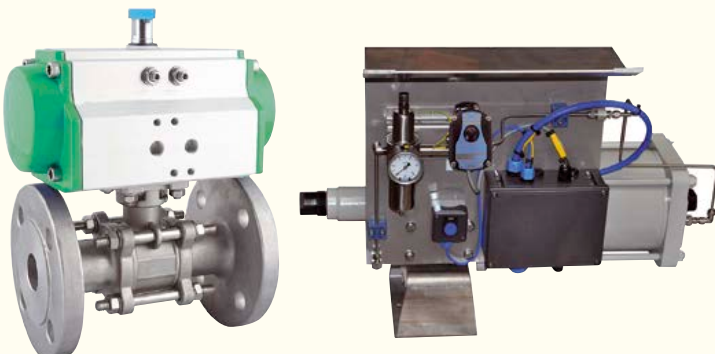

Increased safety “Ex e mb” operator WBLP series

Direct adaptation of the coil on the solenoid valve in a **compact size**.

- Easy electrical installation with a screw terminal.
- **Low power** : 3.5 W (AC) / 4W (DC).
- Thermal fuse integrated.
- Cable entry in all positions (360° rotatable coil).



Ex d IIC and Ex m solenoids

Protection mode for all process industries.

- Ex d IIC answering all Oil & Gas requirements
- Ex m with molded cable for zone 1-21 applications





aluminium enclosure
LI series
Zone 1-21



stainless steel enclosure
WSLI series
Zone 0-20



aluminium enclosure
LPKF series
Zone 1-21



stainless steel enclosure
WSLPKF series
Zone 1-21

Intrinsically safe "Ex ia" operators

"Ex d" operators

Various total safety flameproof operators

A large variety of ATEX certified explosion proof solenoid versions are available in different power levels and materials.

- A same operator for 1/4 to 1/2 solenoid valves.
- Internal diameter designed for a low power and reliable pilot operator.
- The operator can be rotated 360° to select the most favourable position for cable entry.

Solenoid features

Compact metal enclosure to protect the solenoid from severe environment (IP67 protection level)

• **Easy electrical connection**

4 screws on the top of the operator for a reliable air-tightness



2 internal screw terminals for coil connection

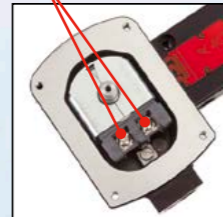

• **Low wattage coil :**

- "Ex ia" operator : 0.5 W (24V DC)
- "Ex d" operator : 0.5 W (24V DC)
- 2.1W (48V DC)
- 2.4 W (AC coils : 24V - 48 V -115 V - 230 V / 50 Hz)

Valve construction

A complete range of 1/4", 1/2" pilot operated spool valves for your pneumatic actuator applications

Our large range of solenoid operators, electrical power levels, valve materials, pilot interfaces, 3/2, 5/2 mono/bistable, 5/3 functions enable these valves to meet your needs for safety and low power consumption.

- **Proven spool technology** (> 20 millions cycles)
- **Stainless Steel screws** (valve and operator)
- 1-3-5 ports on the same side (for "Namur style" solenoid valves)
- **Non breathing construction:** all exhaust ports can be connected to the piping system and valve body designed in order to protect the actuator against particles and contaminants from the environment.

IP67

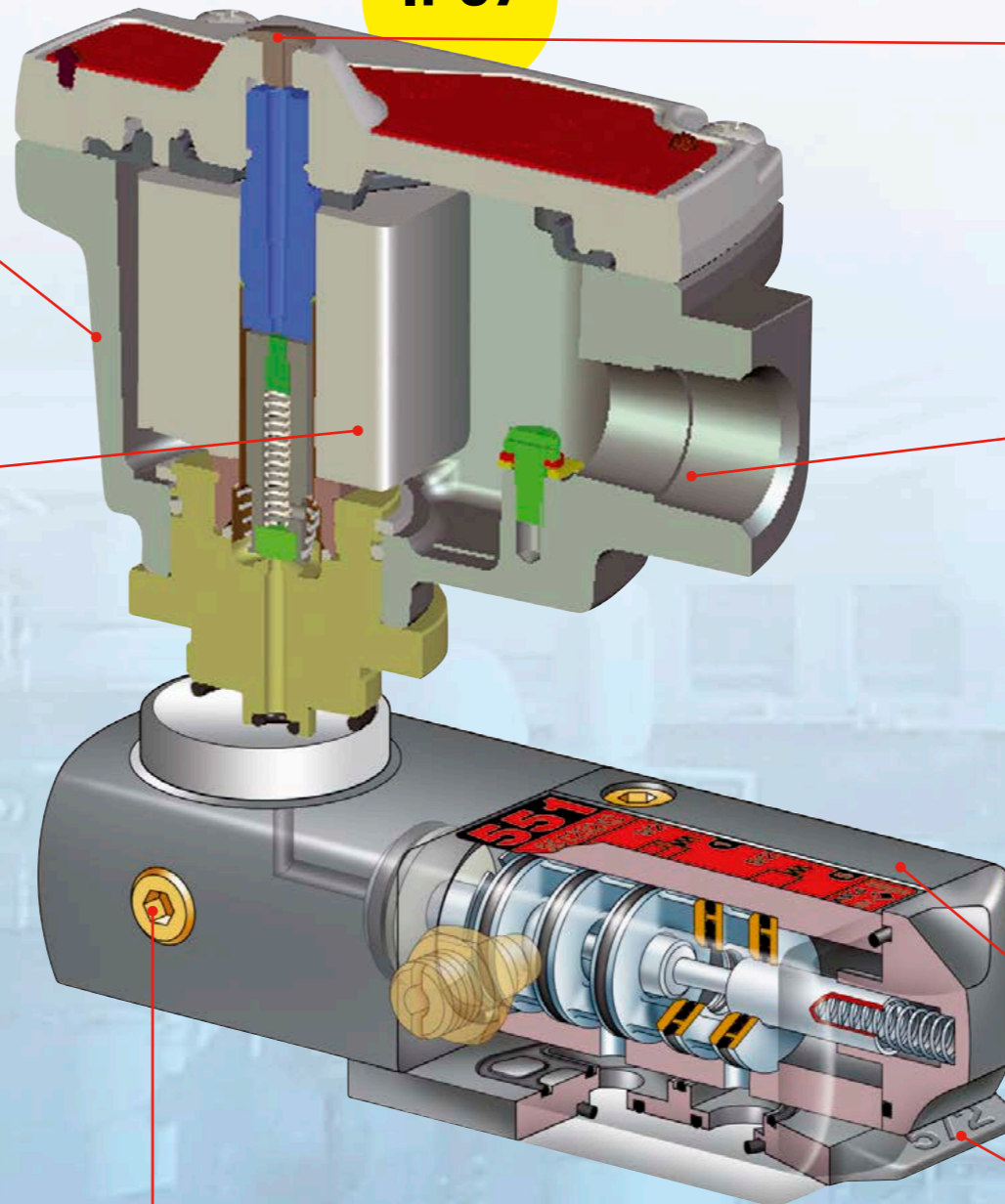

External pilot pressure

Exhaust protection

Standard plastic exhaust dust protection,



Optional exhaust protector + 1/8 NPT



Electrical connection

Any IECEx-ATEX approved cable entry device can be fitted in 1/2 NPT threaded entry hole.

- Optional brass nickel plated cable gland.
- Polyamide cable gland supplied with the "Ex ia" intrinsically safe operator.



Adaptator for M20 x1,5 cable gland

Solenoid valve material :
Aluminium -40 / +60°C
Stainless steel -40 / +80°C
(Brass -40 / +60°C)

NAMUR interface plates with indication of 3/2 or 5/2 functions

Features



Functional Safety

551-553 solenoid valves are certified according to IEC 61508. Functional safety data is available on request. The solenoid valves are approved for use up to SIL 3 loop.



Power Consumption

Various power ratings are available to cover the different flow, temperature and safety requirements.



ATEX-IECEX certification

Compliance with ATEX directive 2014/34/EU for use in potentially explosive atmospheres.



Many operators available with different categories and protection mode.

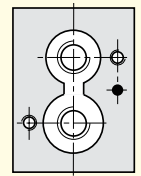

NAMUR Interface (1/4-1/2)

The NAMUR interface has become the pad mount standard for the direct installation of solenoid valves on pneumatic actuators in particular. Each solenoid spool valve is supplied with 2 interface plates enabling use with either 3/2 NC (for single acting actuator piloting) or 5/2 functions (for double acting actuator piloting).

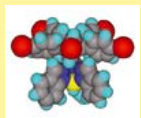

Material for solenoid valves

Series 551-553 solenoid valves are available in aluminum, brass (1/4 only) and 316 stainless steel (1/4-1/2 only) body material.

Features

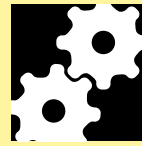

Reliability

High reliability solenoid valves avoid spurious trips and guarantee high reliability even in a 1oo1 configuration.



High Temperature

551-553 solenoid valves and operators are suitable for temperatures up to 80°C (solenoid valves with VMQ (silicone seal).

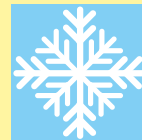

Low Temperature

The spool construction with carefully selected and thoroughly tested seals results in reliable operation, even down to -40°C.



Various Flow Ranges

A large selection of flow is available : from 860 l/min (551 series - 1/4) to 3800 l/min (553 series - 1/2).



Local Approvals

In addition to ATEX approvals, many other approvals are available to meet different standards worldwide. These include KOSHA, NEPSI, CUTR, INMETRO, etc.

Application domains:
Flameproof operators are particularly well adapted in chemical, petrochemical and pharmaceutical industries.



Scan to see ASCO in action
Or go to www.asco.com

The Emerson logo is a trademark and a service mark of Emerson Electric Co. © 2016 Emerson Electric Co.

Fluid Automation. Right. Now.™

