

PRECISE & STURDY CUSHIONING

- Precise cushioning by means of captive micrometer screws
- Large cushioning length

MAGNETIC POSITION DETECTOR



Reed-switch type or magneto-resistive type (MR)
Installation into the T-slot grooves (see page P291)

T-SLOT GROOVES



Grooves in 3 sides

EASY MOUNTING

Wide choice of standard mountings and rod ends

STURDY DESIGN

Rod in hard chrome steel

ESTHETIC DESIGN

Cylinders with profiled barrel in hard anodised aluminium

VERSIONS TO ATEX 

(see page P229-3)

EASY MAINTENANCE

- Series 453 cylinders do not require lubrication
- All the functions in the same side:
 - air ports
 - cushioning adjustment
 - detection

STANDARD SWIVEL TRUNNION MOUNT



As a fastening option, this trunnion slides on the barrel for on-site positioning.

OPTIONS (see page P229-3)

STANDARD MOUNTINGS (see page P229-10)

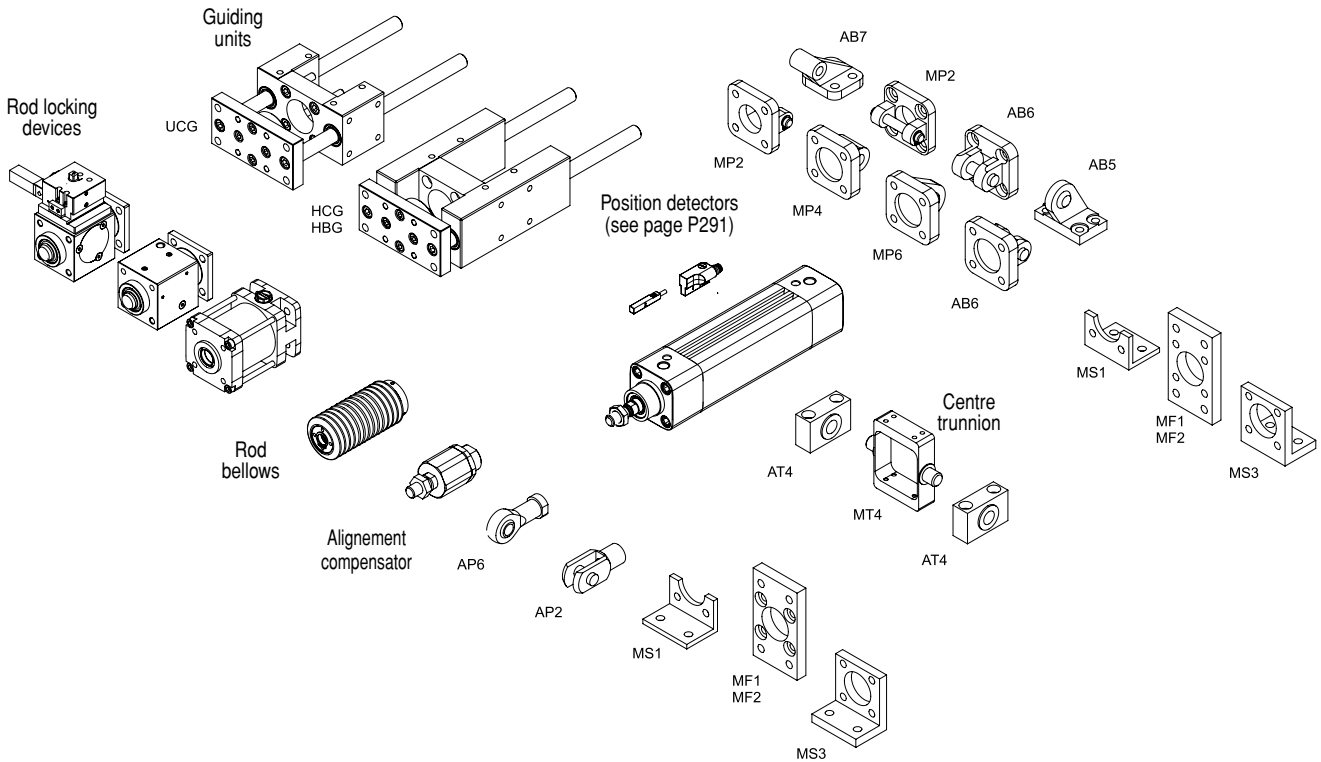

Diagram illustrating various options and standard mountings for the cylinder:

- Guiding units:** UCG, HCG, HBG
- Rod locking devices:** (Three different locking mechanisms)
- Rod bellows:** (Protective bellows for the rod)
- Alignment compensator:** AP6, AP2
- Position detectors:** (see page P291)
- Standard Mountings:** AB7, MP2, AB6, AB5, MP4, MP6, AB6, MS1, MF1, MF2, MS3, AT4, MT4, AT4, MS1, MF1, MF2, MS3

SPECIAL ASSEMBLIES (see page P239-23)

CONFIGURABLE INTO PLUG & PLAY UNITS
5/2 and 5/3 valves with mounting pad to ISO or Namur Mountings, detectors, pneumatic function fittings
Custom solutions assembled and tested on delivery



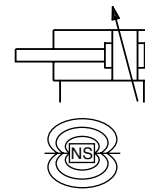

GENERAL

Detection	Equipped for magnetic position detectors
Fluid	Air or inert gas, filtered, lubricated or not
Operating pressure	10 bar, max. [1 bar =100 kPa]
Ambient temperature	-20°C to +70°C (for higher temperature, see HTP option)
Optimal max. speed	≤ 1 m/s (for optimal service life)
Max. speed rate	2 m/s (for higher and lower speed rate, see LFS option)
Standards	ISO 15552-AFNOR NF ISO 15552-DIN ISO 15552

CONSTRUCTION

Barrel	Hard anodized aluminium alloy	
Front and rear ends	Aluminium alloy	
Bearing	Self-lubricating metal	
Cushioning seals	PUR (polyurethane)	
Cushioning	Pneumatic, adjustable from both sides with captive screw	
Rod	Hard chrome plated steel	
Rod nut	Galvanised steel	
Piston	Ø 32 to 80 mm	POM (polyacetal)
	Ø 100 mm	light alloy
	fitted with an annular permanent magnet	
Piston seals	PUR (polyurethane)	



B

HOW TO ORDER

15-DIGIT PRODUCT CODE

G 453 A - S K - - - - A00

Thread connection
G = ISO 16030

Product series
453

Revision letter
A = Initial release

Diameter (mm)
3 = 32
4 = 40
5 = 50
6 = 63
8 = 80
1 = 100

Rod options 1
S = Standard
2 = Through rod
3 = AISI 303 stainless steel rod ⁽¹⁾
4 = AISI 303 stainless steel through rod
⁽¹⁾ 316L stainless steel rod, contact us.

Rod options 2
K = Standard
3 = Static rod-locking device (see P239-8)
4 = Static rod-locking device and manual operator (see P239-8)
5 = Dynamic rod-locking device - Ø 40 to 100 mm (see P239-13)
6 = Oversized piston rod - Ø 63 to 125 mm (see P239-18)
8 = Rod bellow (see P239-20)
T = Eye rod end
Extended piston rod, consult us

Options

- A00** = Without
- MT4** = Non fixed centre trunnion (MT4 axis perpendicular to the ports)⁽¹⁾
- MS4** = Non fixed centre trunnion (MT4 axis parallel to the ports)⁽¹⁾
- UCG** = Plain bearing "U" guiding unit (see P239-1)
- HCG** = Plain bearing "H" guiding unit (see P239-4)
- HBG** = Ball bearing "H" guiding unit (see P239-4)
- AT1** = ATEX zones 1/21
- AT2** = ATEX zones 2/22
- HTP** = High temperature (up to 120°C)⁽²⁾
- FPM** = FPM seals
- FFP** = FPM front end seals
- NPC** = Anticorrosion treatment on covers & high-quality rod seals
- SCN** = Stainless steel cover nuts
- LFS** = Low friction piston seals - Ø 32 to 80 mm⁽³⁾(see P239-22)
- NCS** = Without pneumatic cushioning

⁽¹⁾ For fixed supplied centre trunnion, consult our Dynamic Product Modeling Tool on www.asconumatics.eu and indicate XV dimension.

⁽²⁾ Magnetic detectors cannot be fitted to this version.

⁽³⁾ Special characteristics for this option:

- . piston material: light alloy
- . max. speed rate: 3 m/s

Recommended standard strokes (mm) ⁽¹⁾

Ø mm	connect. Ø (G)	25	50	80	100	125	160	200	250	320	400	500	600	700	800	900	1000	1500	max. stroke
32	G1/8	●	●	●	●	●	●	●	●	●	●	●	●	●	●	●	●	●	2000
40	G1/4	●	●	●	●	●	●	●	●	●	●	●	●	●	●	●	●	●	2000
50	G1/4	●	●	●	●	●	●	●	●	●	●	●	●	●	●	●	●	●	2000
63	G3/8	●	●	●	●	●	●	●	●	●	●	●	●	●	●	●	●	●	2000
80	G3/8	●	●	●	●	●	●	●	●	●	●	●	●	●	●	●	●	●	2000
100	G1/2	●	●	●	●	●	●	●	●	●	●	●	●	●	●	●	●	●	2000

⁽¹⁾ Other strokes on request.

POSITION DETECTORS

Magnetic position detectors must be ordered separately: "T" model (see page P291), reed switch or magneto-resistive type

MOUNTINGS

Mountings must be ordered separately: see page P229-10

DIMENSIONS (mm), WEIGHT (kg)



SINGLE-ROD TYPE CYLINDER

Bare cylinder
ISO 15552



THROUGH-ROD TYPE CYLINDER

Bare cylinder
ISO 15552

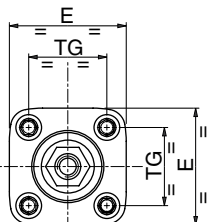
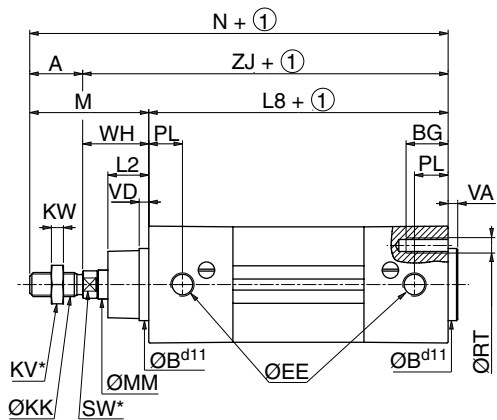

- ① Stroke
- ② Stroke x 2
- * Width across flats

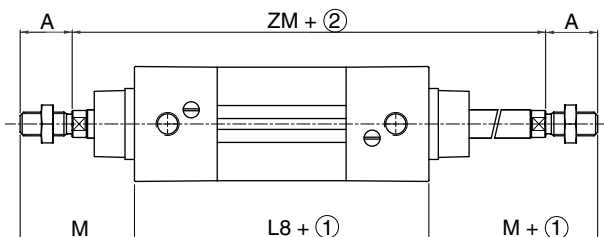

Ø (mm)	A	ØBd11	BG	E	ØEE (3)	ØKK	KV	KW	L2	L8	M	ØMM	N	PL	ØRT	SW	TG	VA	VD min.	WH	ZJ	ZM	weight	
																							(4)	(5)
32	22	30	16	48	G1/8	M10x1,25	16	5	17	94	48	12	142	14	M6	10	32,5 ±0,5	4	4	26	120	146	0,49	0,0029
40	24	35	16	54	G1/4	M12x1,25	18	6	19	105	54	16	159	16	M6	13	38 ±0,5	4	4	30	135	165	0,78	0,0037
50	32	40	16	66	G1/4	M16x1,5	24	8	24	106	69	20	175	18,5	M8	17	46,5 ±0,5	4	4	37	143	180	1,00	0,0053
63	32	45	16	78	G3/8	M16x1,5	24	8	24	121	69	20	190	19	M8	17	56,5 ±0,5	4	4	37	158	195	1,35	0,0057
80	40	45	17	96	G3/8	M20x1,5	30	10	33	128	86	25	214	16,5	M10	22	72 ±0,5	4	4	46	174	220	2,36	0,0086
100	40	55	17	115	G1/2	M20x1,5	30	10	35,5	138	91	25	229	19,5	M10	22	89 ±0,5	4	4	51	189	240	3,46	0,0099

(3) Thread connections 1/4-3/8-1/2 (G*) have standard combination thread according to ISO 228/1 and ISO 7/1. Thread connections G 1/8 have standard thread according to ISO 228/1

(4) Cylinder weight at 0 mm stroke.

(5) Weight to be added per additional mm length.

SPARE PARTS KITS CODE

Ø (mm)	1 + 2 + 3 + 4 ⁽¹⁾		rod + piston unit
32	97802343		97802736 ⁽²⁾
40	97802344		97802737 ⁽²⁾
50	97802345		97802738 ⁽²⁾
63	97802346		97802739 ⁽²⁾
80	97802347		97802740 ⁽²⁾
100	97802259		97802741 ⁽²⁾

⁽¹⁾ For best results, use grease supplied in each kit. Supplementary tube (11 cm³) available on request, catalogue number: **97802100**

⁽²⁾ Specify stroke length (in mm).